

# KENWOOD

AUDIO RECEIVER

## AR-404/KRF-A4030

### INSTRUCTION MANUAL

KENWOOD CORPORATION

This instruction manual is used to describe multiple models listed above. Model availability and features (functions) may differ depending on the country and sales area.

#### ***About the supplied remote control (RC-R0709) . . .***

Compared to standard remote controls, the remote control supplied with this receiver has several operation modes. These modes enable the remote control to control other audio components. In order to effectively use the remote control it is important to read the operating instructions and obtain a proper understanding of the remote control and how to switch its operation modes (etc.).

Using the remote control without completely understanding its design and how to switch the operation modes may result in incorrect operations.

# Before applying power

**⚠ Caution:** Read this page carefully to ensure safe operation.

2

Preparations

Units are designed for operation as follows.

U.S.A. and Canada .....	AC 120 V only
Australia .....	AC 240 V only
China .....	AC 220 V only
* Other countries .....	AC 110-120/220-240 V switchable

## \* AC voltage selection

The AC voltage selector switch on the rear panel is set to the voltage that prevails in the area to which the unit is shipped. Before connecting the power cord to your AC outlet, make sure that the setting position of this switch matches your line voltage. If not, it must be set to your voltage in accordance with the following direction.

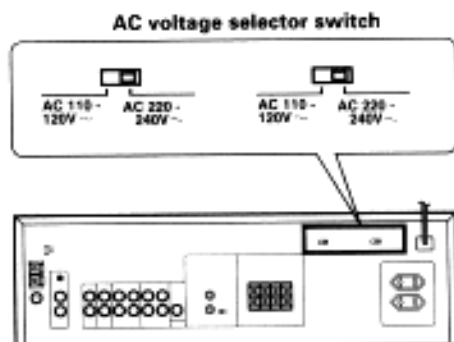

Move switch lever to match your line voltage with a small screwdriver or other pointed tool.

Note:

Our warranty does not cover damage caused by excessive line voltage due to improper setting of the AC voltage selector switch.

## Safety precautions

### WARNING :

TO PREVENT FIRE OR ELECTRIC SHOCK, DO NOT EXPOSE THIS APPLIANCE TO RAIN OR MOISTURE.



### CAUTION

RISK OF ELECTRIC SHOCK  
DO NOT OPEN



CAUTION: TO REDUCE THE RISK OF ELECTRIC SHOCK, DO NOT REMOVE COVER (OR BACK). NO USER-SERVICEABLE PARTS INSIDE, REFER SERVICING TO QUALIFIED SERVICE PERSONNEL.



THE LIGHTNING FLASH WITH ARROWHEAD SYMBOL, WITHIN AN EQUILATERAL TRIANGLE, IS INTENDED TO ALERT THE USER TO THE PRESENCE OF UNINSULATED "DANGEROUS VOLTAGE" WITHIN THE PRODUCT'S ENCLOSURE THAT MAY BE OF SUFFICIENT MAGNITUDE TO CONSTITUTE A RISK OF ELECTRIC SHOCK TO PERSONS.



THE EXCLAMATION POINT WITHIN AN EQUILATERAL TRIANGLE IS INTENDED TO ALERT THE USER TO THE PRESENCE OF IMPORTANT OPERATING AND MAINTENANCE (SERVICING) INSTRUCTIONS IN THE LITERATURE ACCOMPANYING THE APPLIANCE.

## Unpacking

Unpack the unit carefully and make sure that all accessories are put aside so they will not be lost.

Examine the unit for any possibility of shipping damage. If your unit is damaged or fails to operate, notify your dealer immediately. If your unit was shipped to you directly, notify the shipping company without delay. Only the consignee (the person or company receiving the unit) can file a claim against the carrier for shipping damage.

We recommend that you retain the original carton and packing materials for use should you transport or ship the unit in the future.

Keep this manual handy for future reference.

## Accessories

FM indoor antenna (1)



AM loop antenna (1)



Remote control unit (1)



Batteries (R06/AA) (2)



\*AC plug adaptor (1)



\*Use to adapt the plug on the power cord to the shape of the wall outlet.  
(Accessory only for regions where use is necessary.)

## Maintenance of the set

When the front panel or case becomes dirty, wipe with a soft, dry cloth. Do not use thinner, benzine, alcohol, etc. for these agents may cause discoloration.

## In regard to contact cleaner

Do not use contact cleaners because it could cause a malfunction. Be specially careful not to use contact cleaners containing oil, for they may deform the plastic component.

## Special features

### MONITOR

The **TAPE2/MONITOR** jacks of this unit accept the connection of a cassette deck, graphic equalizer, surround processor, etc. When a 3-head cassette deck is connected to the **TAPE2/MONITOR** jacks, it is possible to monitor the sound which has just been recorded during recording. - [12]

### Station preset

This unit incorporates a function for storing received stations in preset memory with a simple operation. It is very convenient to preset the stations you like. The preset stations can be recalled also very easily. - [13]

### Remote controllable audio function

By connecting **KENWOOD** source components such as a cassette deck and CD player through system control connection, the basic operations of these components can be controlled from the remote control unit provided with this unit. A single remote control unit can control the entire audio system easily.

### New "TRAIT" transistor (Except for U.S.A. and Canada)

The new developed "TRAIT" transistor with extremely superior temperature characteristics is used in this amplifier's amplification circuit. Through the use of this transistor, distortion generated because of temperature change is kept to a minimum resulting in "pure" sound reproduction.

### K-STAT Discrete Audio Amplifier

(For U.S.A. and Canada)

Exclusive Kenwood-developed output circuitry incorporating a thermal compensation sensor inside the power transistor housing. This eliminates any amplifier warm-up period and allows the amplifier to instantaneously adjust to temperature changes, greatly improving sound quality and consistency at all volume levels.

K-STAT is the world's first transistor designed specifically for audio amplification purposes.

## How to use this manual

This manual is divided into three sections, Preparations, Operations, and Other.

### Preparations

Shows you how to connect your audio components to the receiver.

We've tried to make setting up your system as easy as possible. However, since this receiver works with all of your audio components, connecting the system can be fairly complex.

### Operations

Shows you how to operate the various functions available from the receiver.



### Other

Shows you additional information such as "In case of difficulty" (troubleshooting) and "Specifications."

## Contents

**Caution** : Read the pages marked  carefully to ensure safe operation.

### Preparations

 <b>Before applying power</b> .....	<b>2</b>
 Safety precautions .....	2
Unpacking .....	2
Special features .....	3
How to use this manual .....	3
 <b>Setting up the system</b> .....	<b>4</b>
Connecting audio components .....	4
Connecting the antennas .....	5
Connecting the speakers .....	5
Connecting the system control .....	6
<b>Names and functions of parts</b> .....	<b>7</b>
Main unit .....	7
Remote control unit .....	8
Preparing the remote control .....	9
FM DE-EMPHASIS / CHANNEL SPACE switch .....	9

### Operations

<b>Normal playback</b> .....	<b>10</b>
Preparing for playback .....	10
Listening to a source component .....	10
Adjusting the sound .....	11
<b>Recording</b> .....	<b>12</b>
Recording audio .....	12
<b>Listening to radio broadcasts</b> .....	<b>13</b>
Tuning radio stations .....	13
Presetting radio stations manually .....	13
Receiving preset stations .....	13
Receiving preset stations in order (P.CALL) .....	13

### Other

<b>In case of difficulty</b> .....	<b>14</b>
 <b>Specifications</b> .....	<b>16</b>



As an **ENERGY STAR**® Partner, Kenwood Corporation has determined that this products meets the **ENERGY STAR**® guidelines for energy efficiency.

This product can save energy. Saving energy reduces air pollution and lowers utility bills.

# Setting up the system

**Caution:** Read this page carefully to ensure safe operation.

Make connections as shown below.

When connecting the related system components, be sure to also refer to the instruction manuals supplied with the components you are connecting.

Do not connect the power cord to a wall outlet until all connections are completed.

## Microcomputer malfunction

If operation is not possible or an erroneous display appears, even though all connections have been made properly, reset the microcomputer referring to "In case of difficulty".

## CAUTION (Except for U.S.A. and Canada)

Be sure to adhere followings. Or proper ventilation will be blocked causing damage or fire hazard.

- Do not place any objects impairing heat radiation onto the top of unit.
- Leave a space around the unit (from the largest outside dimension including projection) equal or greater than, shown below.

Top panel : 50 cm  
Side panel : 10 cm  
Back panel : 10 cm

## CAUTION (For U.S.A. and Canada)

Be sure to adhere followings. Or proper ventilation will be blocked causing damage or fire hazard.

- Do not place any objects impairing heat radiation onto the top of unit.

### Notes:

1. Be sure to insert all connection cords securely. If their connections are imperfect, the sound may not be produced or noise may interfere.
2. Be sure to remove the power cord from the AC outlet before plugging or unplugging any connection cords. Plugging / unplugging connection cords without disconnecting the power cord can cause malfunctions and may damage the unit.
3. Do not connect power cords from components whose power consumption is larger than what is indicated on the AC outlet at the rear of this unit.

## Connecting audio components

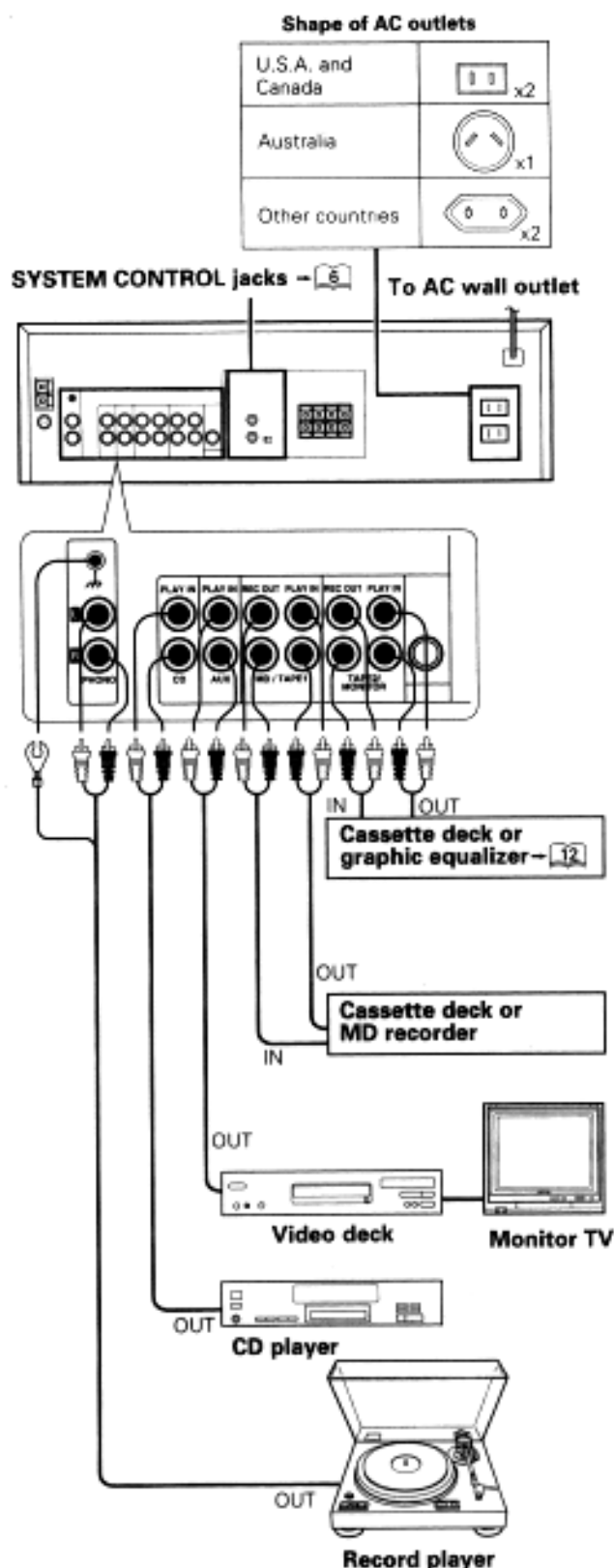

## Connecting the antennas

### AM antenna terminal connections

- ① Push lever.    ② Insert cord.    ③ Return lever.



### AM loop antenna

The supplied loop antenna is for use indoors. Place it as far as possible from the receiver, TV set, speaker cords and power cord, and adjust the direction for best reception.

### FM indoor antenna

The supplied indoor antenna is for temporary use only. For stable signal reception we recommend using an outdoor antenna. Disconnect the indoor antenna when you connect one outdoors.

### FM outdoor antenna

Lead the 75Ω coaxial cable connected to the FM outdoor antenna into the room and connect it to the FM 75Ω terminal.

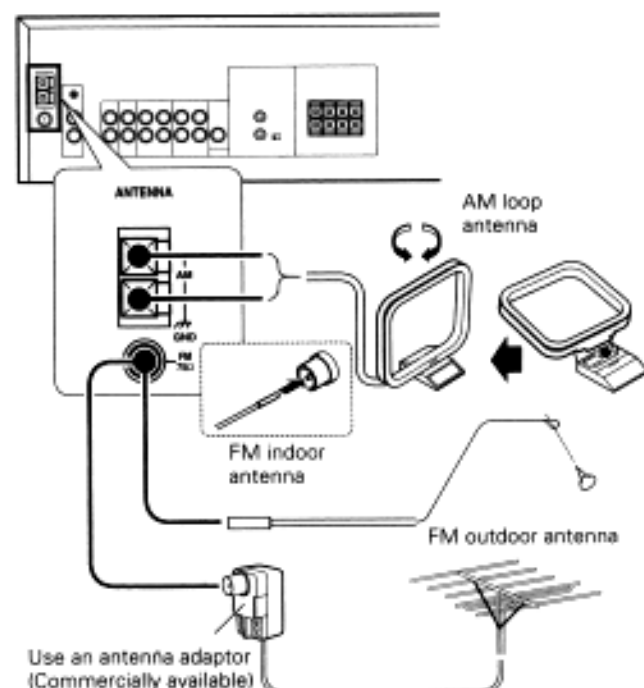

## Connecting the speakers

- ① Strip coating.



- ② Push lever.



- ③ Insert cord.



- ④ Return lever.

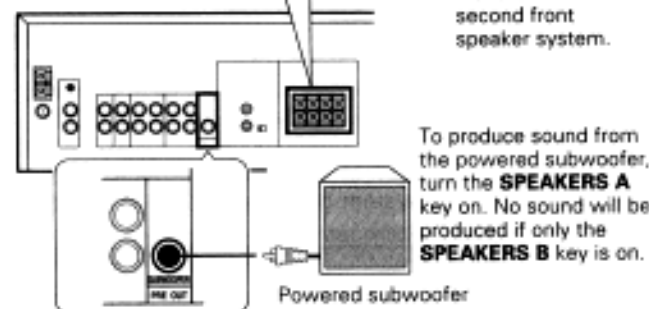
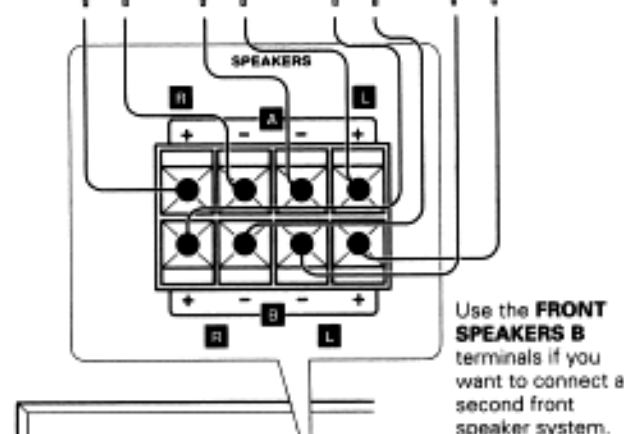
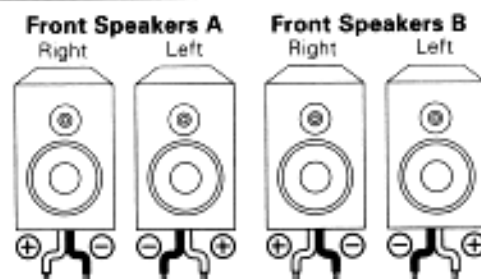

- Never short circuit the + and - speaker cords.
- If the left and right speakers are connected inversely or the speaker cords are connected with reversed polarity, the sound will be unnatural with ambiguous acoustic imaging. Be sure to connect the speakers correctly.

### Speaker impedance

After confirming the speaker impedance indications printed on the rear panel of the receiver, connect speakers with matching impedance ratings. Using speakers with a rated impedance other than that indicated on the rear panel of the receiver could result in malfunctions or damage to the speakers or receiver.

## Connecting the system control

Connecting system control cords after connecting a KENWOOD audio component system lets you take advantage of convenient system control operations.

This unit is compatible only with the [SL16] mode. The system control operation is not available if the unit is connected in the [XS-8], [XS], or [XR] connection mode.

If your component has the mode select switch, set the connected components to the [SL16] mode.

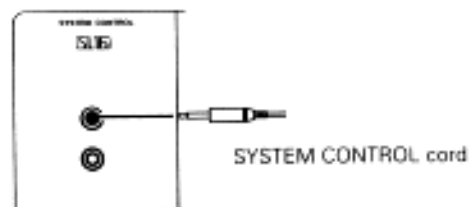

### EXAMPLE: [SL16] mode connections

The underlined portion represents the setting of the system control mode.

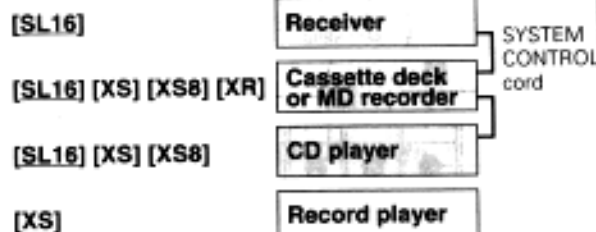

- In order to take advantage of the system control operations, the components must be connected to the correct jacks. To use a CD player it must be connected to the CD jacks. To use a cassette deck (or MD recorder) it must be connected to the MD/TAPE jacks. When using more than one CD player (etc.) only the one connected to the specified jacks may be connected for system control.
- Some CD players and cassette decks are not compatible with the **[SL16]** system control mode.
- Some MD players are not system control compatible. You cannot make system control connections to this kind of equipment.

#### Notes

1. **[SL16]** equipment cannot be combined with **[XR]**, **[XS]**, and **[XS8]** equipment for system operations. If your equipment consists of this kind of combination, please do not connect any system control cords. Even without system control cords, normal operations can be carried out without effecting performance.
2. Do not connect system control cords to any components other than those specified by **KENWOOD**. It may cause a malfunction and damage your equipment.
3. Be sure the system control plugs are inserted all the way in to the system control terminals.

Do not connect a system control cord to a cassette deck connected to the TAPE2/MONITOR jacks.

### SYSTEM CONTROL operations

#### Remote Control

Lets you operate this unit with the system remote supplied with the receiver.

#### Automatic Operation

When you start playback from a source component, the input selector on this unit switches to that component automatically.

#### Synchronized Recording

Lets you synchronize recording with the start of playback when recording from CD, MD or analog discs.



## Remote control unit

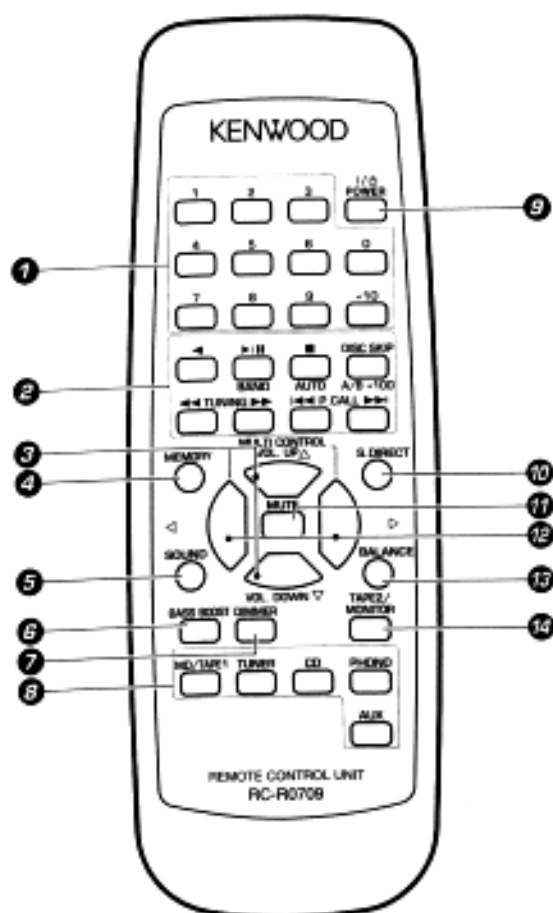

Model: RC-R0709  
Infrared ray system

### 1 Numeric keys (1-0, +10)

If CD or MD is selected as the input source, these keys function as numeric keys. If tuner is selected as the input source, these keys are used to call up station presets.

### 2 Component operation keys

Use these keys to operate other components with system control connections to the receiver.

#### TUNING (←← →→) keys

If tuner is selected as the input source, these keys function as tuning keys.

If CD or MD is selected as the input source, these keys function as search keys.

#### P.CALL (←← →→) keys

If tuner is selected as the input source, these keys function as P.CALL keys.

If CD or MD is selected as the input source, these keys function as skip keys.

#### ◀ key

If tape is selected as the input source, this key functions as the play key for side B of the cassette (the side facing away from the front of the deck).

#### BAND (▶/■) key

If tuner is selected as the input source, this key functions as the band selector key.

If CD is selected as the input source, this key functions as the play/pause key.

If MD is selected as the input source, this key functions as the play key.

#### DISC SKIP, A/B, +100 key

If CD is selected as the input source, this key functions as the multi-CD player disc skip key.

If TAPE is selected as the input source, this key is used to switch between the two decks (A and B) of a double cassette deck.

If MD is selected as the input source, this key function as numeric key.

#### AUTO(■) key

If tuner is selected as the input source, this key functions as the AUTO key.

If CD or MD is selected as the input source, this key functions as the stop key.

#### 3 VOLUME UP, DOWN keys

Use to adjust the sound quality.

4 MEMORY key

Use to store radio stations in the preset memory.

#### 5 SOUND key

Use to adjust the sound quality.

#### 6 BASS BOOST key

Use to select the maximum adjustment setting for the low frequency range.

#### 7 DIMMER key

Use to adjust the brightness of the display.

#### 8 Input selector keys

Use to select the receiver's input source.

#### 9 POWER (I/O) key

Use to switch the power ON/STANDBY when the POWER is turned ON.

#### 10 S.DIRECT key

Use to temporarily mute the sound.

#### 11 MULTI CONTROL keys

Used to make a variety of settings.

#### 12 BALANCE key

Use to adjust the sound balance.

#### 13 TAPE2/ MONITOR key



## Preparing the remote control

### Loading the batteries

- ① Remove the cover.      ② Insert the batteries.

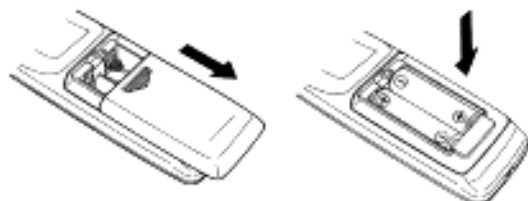

- ③ Close the cover.

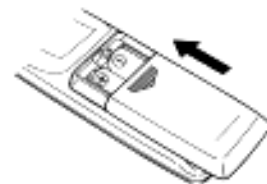

- Insert two AA-size (R06) batteries as indicated by the polarity markings.

### Operation

When the "STANDBY" indicator is lit, the power turns ON when you press the **POWER** (1/⊕) key on the remote control. When the power comes ON, press the key you want to operate.

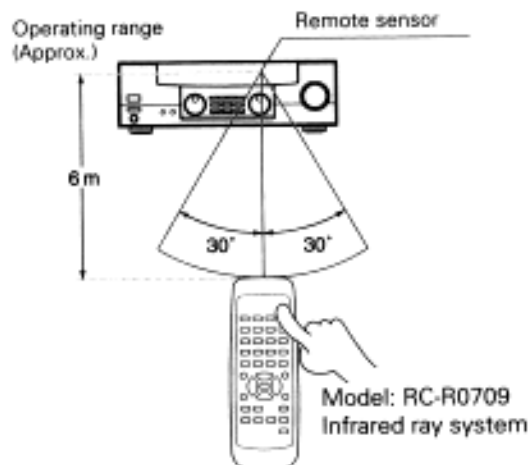

- When pressing more than one remote control key successively, press the keys securely by leaving an interval of 1 second or more between keys.

#### Notes:

1. The supplied batteries may have shorter lives than ordinary batteries due to use during operation checks.
2. When the remote-controllable distance gets shorter than before, replace both batteries with new ones.
3. Placing the remote sensor in direct sunlight, or in direct light from a high frequency fluorescent lamp may cause a malfunction. In such a case, change the location of the system installation to prevent malfunction.

## FM DE-EMPHASIS / CHANNEL SPACE switch

(Except for the U.S.A., Canada and Australia)

The **DE-EMPHASIS / CHANNEL SPACE** switch on the rear panel is set to the correct setting that prevails in the area to which the unit is shipped. However, if the **DE-EMPHASIS / CHANNEL SPACE** setting is not matched to the area where the unit is to be used; for instance, when you moved from area 1 to area 2 or vice versa, desired reception of AM / FM broadcasts is not expected. In this case, change the **DE-EMPHASIS / CHANNEL SPACE** setting in accordance with the area corresponding to the table. The **DE-EMPHASIS** is switched over at the same time.

- When changing the setting of the **DE-EMPHASIS / CHANNEL SPACE** switch, first disconnect the power cord of the amplifier, then change the channel space switch, connect the power cord again, and turn the power on.

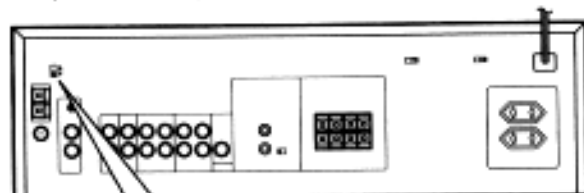

ANTENNA	75 $\mu$ s FM 100kHz AM 10kHz	DE-EMPHASIS CHANNEL SPACE
	50 $\mu$ s FM 50kHz AM 9kHz	

Area	CHANNEL SPACE freq.	FM DE-EMPHASIS
1 U.S.A., Canada, Hawaii, South American countries	FM : 100kHz AM : 10kHz	75 $\mu$ s
2 Other countries	FM : 50kHz AM : 9kHz	50 $\mu$ s

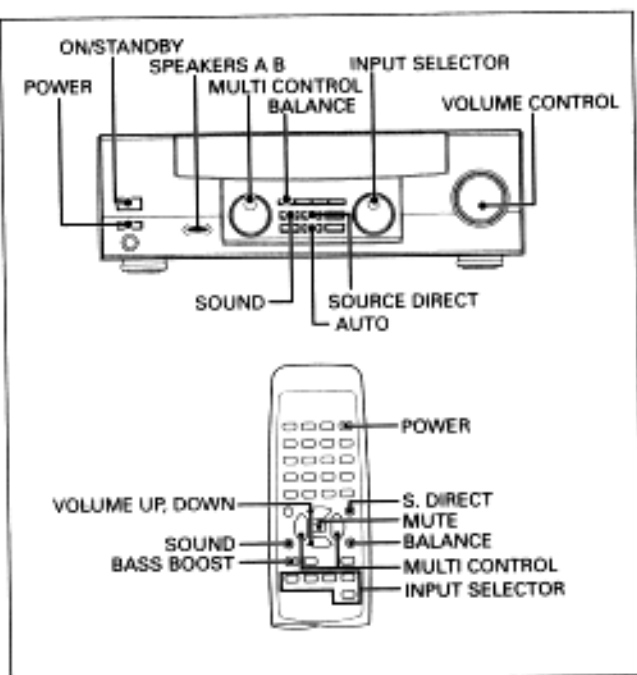

## Selecting the speaker system

Press the **SPEAKERS A** or **B** key to select the speaker system to be used.

- A ON** : Sound from the speakers connected to the **SPEAKERS A** terminals on the rear panel.
- B ON** : Sound from the speakers connected to the **SPEAKERS B** terminals on the rear panel.
- A+B ON** : Sound from both the speakers connected to the **SPEAKERS A** and **B** terminals on the rear panel.
- A+B OFF** : No sound from the speakers. Use this setting when listening with headphones.

The indicator for the speakers you want to use should be lit.

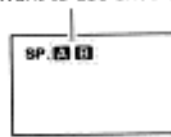

## Listening to a source component

- 1** Use the **input selector (INPUT SELECTOR)** to select the source you want to listen to.

The input sources change as shown below:

### Selecting a source using the INPUT SELECTOR

- 1 TUNER (frequency display)
- 2 "CD"
- 3 "TAPE 1" or "MD"
- 4 "PHONO"
- 5 "AUX"

- When selecting an input source by using the remote control, press the desired input selector key.
- The **INPUT SELECTOR** on the front panel of the receiver always cycles through all inputs.

- 2** Start playback from the selected source.

- 3** Use the **VOLUME CONTROL (VOLUME UP, DOWN)** to adjust the volume.

- The sound of input source cannot be listened to with **TAPE2/MONITOR** is ON.

## Preparing for playback

Some preparatory steps are needed before starting playback.

### Turning on the receiver

- 1** Turn on the **POWER** key to **ON**.  
(Except for U.S.A. and Canada)
- 2** Turn on the power to this receiver by pressing **ON/STANDBY** (I/O) key.

### Selecting MD/TAPE 1 (Main unit only)

Select the source name corresponding to the component connected to the **MD/TAPE1** jacks. The initial factory setting is **"TAPE 1"**. To change the source name associated with the **MD/TAPE1** jacks to **"MD"**, follow the steps below:

- 1** Use the **INPUT SELECTOR** knob to select **"TAPE 1"**.
- 2** Hold down the **AUTO** key for more than 2 seconds.
  - The source indication changes to **"MD"**.
  - To return to the original indication, repeat the above procedure.

## Adjusting the sound

### Adjusting the tone

Use the following procedure to adjust the bass and treble levels.

- ① Press the **SOUND** key to select the tone mode to be adjusted.

**BASS** : Select this to adjust the low frequency range.  
(Press the **SOUND** key once.)

**TREBLE** : Select this to adjust the high frequency range.  
(Press the **SOUND** key twice.)

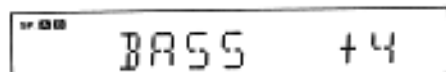

- ② Use the **MULTI CONTROL** to adjust the sound quality.

- The bass and treble levels are adjustable from -10 to +10 in 2 step increments.
- The adjustment item is displayed for approximately 8 seconds.

### Once-touch low frequency emphasis (BASS BOOST) (Remote control only)

Use the following procedure to emphasize the bass and create a richer sound.

Press the **BASS BOOST** key.

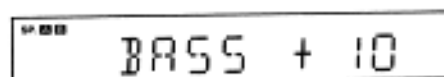

- Press the **BASS BOOST** key once to select the maximum (+10) low frequency emphasis setting.

### Switching back to the previous setting

Press the **BASS BOOST** key again.

### Muting the sound (Remote control only)

MUTE lets you mute the sound of the speakers.

Press the **MUTE** key.

Blinks

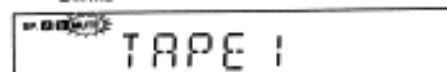

- Muting can also be cancelled by adjusting the volume.

### To cancel

Press the **MUTE** key again so that the "MUTE" indicator goes off.

### SOURCE DIRECT playback

Use this function to pass the source material direct to the amplifier, by passing any audio processing.

Press the **SOURCE DIRECT (S.DIRECT)** key.

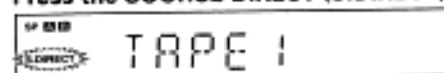

- Switch to another input source to cancel **SOURCE DIRECT (S.DIRECT)** playback.

### To cancel

Press the **SOURCE DIRECT (S.DIRECT)** key again.

### Listening with headphones

- ① Press the **SPEAKERS A** or **B** key so that the speaker indicator goes off.

Make sure the **SPEAKERS** indicators are turned off.

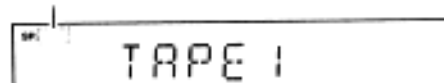

- ② Connect headphones to the **PHONES** jack.



- ③ Use the **VOLUME CONTROL (VOLUME UP, DOWN)** to adjust the volume.

### To adjust the BALANCE

The mode for adjusting the volume balance between the left and right.

- ① Press the **BALANCE** key.
- ② Use the **MULTI CONTROL** to adjust the balance.

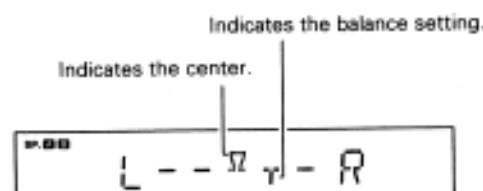

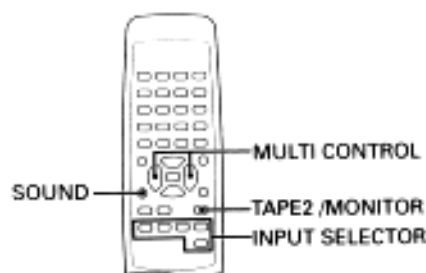
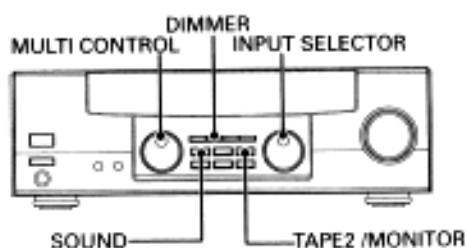

## Recording audio

### Recording a music source

- 1 Use the input selector (INPUT SELECTOR) to select the source (other than "TAPE 1") you want to record.
- 2 Set the cassette deck to record.
- 3 Start playback, then start recording.

### Copying tapes

#### TAPE 1 → TAPE 2 copying

- 1 Use the input selector to select "TAPE 1".
- 2 Start playback on the cassette deck connected to the MD/TAPE1 jacks and start recording on the cassette deck connected to the TAPE2/MONITOR jacks.
  - To copy tapes using a double cassette deck, refer to the instruction manual of the double cassette deck.

### Display dimmer adjustment

The dimmer function lets you select the brightness of the receiver's display. You might find this useful if you darken your room to watch movies or listen to music.

Each time you press the DIMMER key, the display brightness changes among the three available settings. Select the brightness level you find most pleasing.

### TAPE2/MONITOR function

You can connect a cassette deck or graphic equalizer to the **TAPE2/MONITOR** jacks of the receiver. If a graphic equalizer is connected, the **TAPE2/MONITOR** key should be left in the on position. Alternately, if a cassette deck equipped with a 3-head system is connected to the **TAPE2/MONITOR** jacks, you will be able to monitor the just-recorded signal while making recordings on the cassette deck. By switching the **TAPE2/MONITOR** key on and off, you can compare the sound of the source signal and the just-recorded signal. For more information, refer to the instruction manual of the connected component.

- The equalizer effect can be applied to the played audio but cannot be recorded together with the audio signal.
- Copy from "TAPE 2" to "TAPE 1" is not possible.

### Input level adjustment (when using the monitor function)

If the input level while using the monitor function is too high, adjust the input level as described below.

The input level cannot be adjusted when in the source direct playback mode.

- 1 Press the TAPE2/MONITOR key.
- 2 Press the SOUND key several times until the "INPUT" indication appears.
- 3 Use the MULTI CONTROL to adjust the input level.

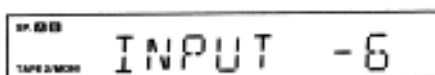

- The adjustment mode is displayed for approximately 8 seconds.
- The input level may be adjusted to any one of 2 settings: 0 and -6. (The initial setting is 0.)

- 4 Press the SOUND key to return to the input indication.

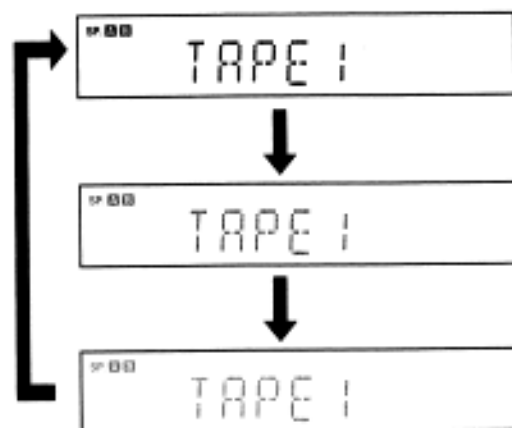

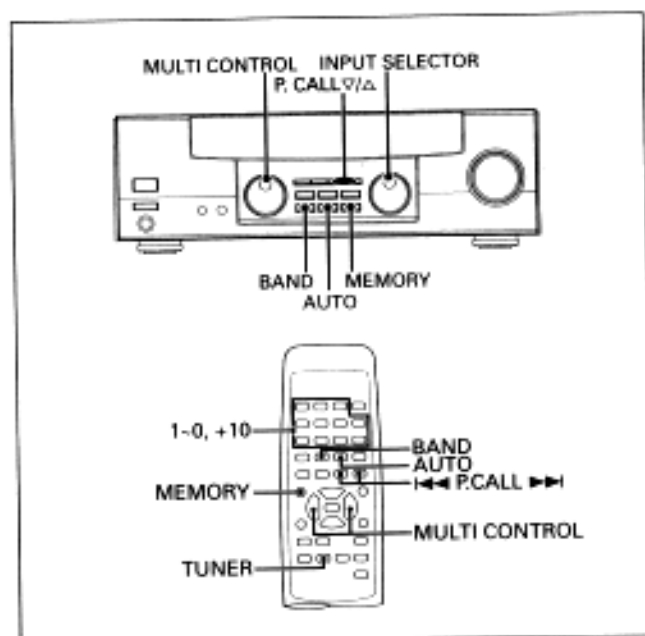

## Presetting radio stations manually

- 1 Tune to the station you want to store.
- 2 Press the **MEMORY** key while receiving the station.

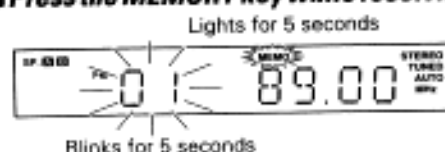

Proceed to step 3 within 5 seconds. (If more than 5 seconds elapse, press the **MEMORY** key again).

- 3 Use the **MULTI CONTROL** to select one of the station presets (1 – 40).
- 4 Press the **MEMORY** key to accept the setting.
  - Repeat steps 1, 2, 3 and 4 to store as many stations as necessary.
  - If you store a station at a previously used preset, the old station will be replaced by the new one.

## Tuning radio stations

- 1 Use the input selector (**INPUT SELECTOR**) to select the tuner.
- 2 Use the **BAND** key to select the desired broadcast band.

Each press switches the band as follows:

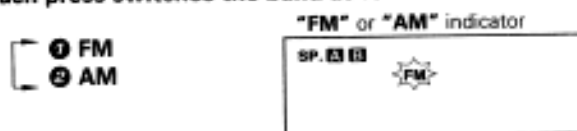

- 3 Use the **AUTO** key to select the desired tuning method.

Each press switches the tuning method as follows:

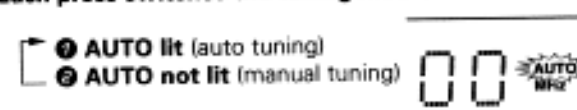

- Normally, set to "AUTO" (auto tuning). If the radio waves are weak and there is a lot of interference, switch to manual tuning. (With manual tuning, stereo broadcasts will be received in monaural.)

- 4 Use the **MULTI CONTROL** to select the station.

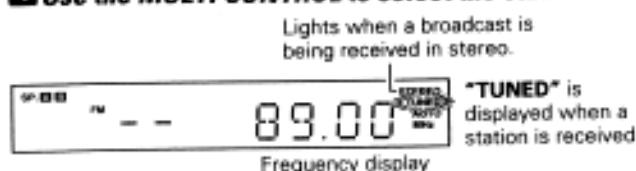

- Auto tuning** : The next station is tuned automatically.
- Manual tuning** : Turn the knob (press the key) to select the desired station.

- You can also use the **TUNING** key on the remote control to make the selection.

## Receiving preset stations

- 1 Use the input selector (**INPUT SELECTOR**) to select the tuner.
- 2 Using the remote control unit, enter the number of the preset you want to receive (up to "40").

Press the numeric keys in the following order:

For "15", press ..... [+10] . [5]  
 For "20", press ..... [+10] . [+10] . [0]

- If you make a mistake entering a two digit number, press the [+10] key several times to return to the original display and start again.

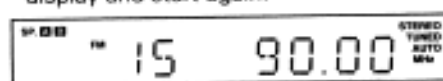

## Receiving preset stations in order (P.CALL)

- 1 Use the input selector (**INPUT SELECTOR**) to select the tuner.
- 2 Use the **P.CALL** key to select the desired station.

- Each time you press the **P.CALL** key, another preset station is received in order.

Pressing the **P.CALL** (▶▶) key (**P.CALL**Δ) does the following:  
 01→02→03→...38→39→40→01→02→03→

Pressing the **P.CALL** (◀◀) key (**P.CALL**∇) does the following:  
 01←02←03←...38←39←40←01←02←03←

Holding down the **P.CALL** key, lets you skip through the presets, receiving each for 0.5 seconds apiece.

## Resetting the Microcomputer

If the microcomputer may malfunction (unit cannot be operated, or shows an erroneous display) if the power cord is unplugged while the power is ON, or due to some other external factor. If this happens, execute the following procedure to reset the microcomputer and return the unit to its normal operating condition.

*For U.S.A. and Canada*

**Unplug the power cord from the wall outlet, then plug it back in while holding down the POWER key.**

*Except for U.S.A. and Canada*

**With the power cord plugged in, turn the POWER key OFF. Then, while holding down the ON/STANDBY key, press the POWER key.**

- Please note that resetting the microcomputer will clear the contents of the memory and returns the unit to the state it was in when it left the factory.

## Amplifier

Symptom	Cause	Remedy
No sound from the speakers.	<ul style="list-style-type: none"> <li>• The speaker cords are disconnected.</li> <li>• VOLUME is set to the minimum position.</li> <li>• MUTE is ON.</li> <li>• The <b>SPEAKERS</b> switches are set to OFF.</li> </ul>	<ul style="list-style-type: none"> <li>• Connect properly referring to "<b>Setting up the system</b>". - [5]</li> <li>• Adjust the volume to a proper level.</li> <li>• Turn OFF the MUTE. - [11]</li> <li>• Set the <b>SPEAKERS</b> switch(es) to ON. - [10]</li> </ul>
The standby indicator blinks and sound is not output.	<ul style="list-style-type: none"> <li>• Speaker cords are short-circuited.</li> </ul>	<ul style="list-style-type: none"> <li>• Turn the power off, eliminate the short-circuiting, then turn on the power again. - [5]</li> </ul>
Sound is not output from one of the speakers.	<ul style="list-style-type: none"> <li>• The speaker cord is disconnected.</li> </ul>	<ul style="list-style-type: none"> <li>• Connect properly referring to "<b>Setting up the system</b>". - [5]</li> </ul>
A humming noise is generated when the PHONO input selector is selected.	<ul style="list-style-type: none"> <li>• The audio cord from the turntable is not connected to the <b>PHONO</b> jacks.</li> <li>• The turntable is not grounded.</li> </ul>	<ul style="list-style-type: none"> <li>• Insert the audio cord plugs securely into the <b>PHONO</b> jacks.</li> <li>• Connect the grounding wire to the GND terminal on the rear panel. - [4]</li> </ul>

## Tuner

Symptom	Cause	Remedy
Radio stations cannot be received.	<ul style="list-style-type: none"> <li>• No antenna is connected.</li> <li>• The broadcast band is not set properly.</li> <li>• The frequency of the desired station is not tuned.</li> </ul>	<ul style="list-style-type: none"> <li>• Connect an antenna. - [5]</li> <li>• Set the broadcast band properly.</li> <li>• Tune the frequency of the desired station. - [13]</li> </ul>
Interference.	<ul style="list-style-type: none"> <li>• Noise due to ignition noise from an automobile.</li> <li>• Noise due to interference from an electric appliance.</li> <li>• Noise due to a nearby TV set.</li> </ul>	<ul style="list-style-type: none"> <li>• Install the outdoor antenna away from the road.</li> <li>• Turn off the power to the appliance.</li> <li>• Install the receiver farther away from the TV.</li> </ul>
A station which was preset cannot be received by pressing the corresponding numeric key.	<ul style="list-style-type: none"> <li>• The preset station belongs to a frequency that cannot be received.</li> <li>• The preset memory was cleared because the power cord had been unplugged for a long period of time.</li> </ul>	<ul style="list-style-type: none"> <li>• Preset a station with a receivable frequency.</li> <li>• Preset the station again.</li> </ul>

**Remote control unit**

Symptom	Cause	Remedy
Remote control operation is not possible.	<ul style="list-style-type: none"> <li>• Batteries are exhausted.</li> <li>• The remote control unit is too far away from the main system, controlling angle is too large, or there is an obstacle between the receiver and the remote.</li> <li>• The audio cords and system control cords are not connected properly.</li> <li>• No software is loaded in the source component.</li> <li>• An attempt is made to play a tape which is being recorded in the cassette deck.</li> </ul>	<ul style="list-style-type: none"> <li>• Replace with new batteries. — 9</li> <li>• Operate the remote control unit within the controllable range.</li> <li>• Connect properly referring to "Setting up the system". — 4 — 6</li> <li>• Place software in the source component you want to play.</li> <li>• Wait until recording has completed.</li> </ul>

**Memory back up function****For U.S.A. and Canada**

Please note that the following items will be deleted from the unit's memory if the power cord is disconnected from the AC outlet for approximately 3 days.

**Except for U.S.A. and Canada**

Please note that the following items will be deleted from the unit's memory if the power cord is disconnected from the AC outlet or the main power switch is turned off for approximately 3 days.

- Power mode
- Input selector settings
- Volume level
- Broadcast band
- Frequency setting
- Preset stations

**For the U.S.A.****FCC WARNING**

This equipment may generate or use radio frequency energy. Changes or modifications to this equipment may cause harmful interference unless the modifications are expressly approved in the instruction manual. The user could lose the authority to operate this equipment if an unauthorized change or modification is made.

**NOTE:**

This equipment has been tested and found to comply with the limits for a Class B digital device, pursuant to Part 15 of the FCC Rules. These limits are designed to provide reasonable protection against harmful interference in a residential installation. This equipment may cause harmful interference to radio communications, if it is not installed and used in accordance with the instructions. However, there is no guarantee that interference will not occur in a particular installation. If this equipment does cause harmful interference to radio or television reception, which can be determined by turning the equipment off and on, the user is encouraged to try to correct the interference by one or more of the following measures:

- Reorient or relocate the receiving antenna.
- Increase the separation between the equipment and receiver.
- Connect the equipment into an outlet on a circuit different from that to which the receiver is connected.
- Consult the dealer or an experienced radio / TV technician for help.

**Note to CATV system installer:**

This reminder is provided to call the CATV system installer's attention to Article 820-40 of the NEC that provides guidelines for proper grounding and, in particular, specifies that the cable ground shall be connected to the grounding system of the building, as close to the point of cable entry as practical.





# IMPORTANT SAFEGUARDS

▲ *Caution: Read this page carefully to ensure safe operation*

(EN)

Please read all of the safety and operating instructions before operating this appliance. Adhere to all warnings on the appliance and in the instruction manual. Follow all the safety and operating instructions. These safety and operating instructions should be retained for future reference.

**1. Power sources** – The appliance should be connected to a power supply only of the type described in the instruction manual or as marked on the appliance. If you are not sure of the type of power supply to your home, consult your appliance dealer or local power company. For appliances intended to operate from battery power, or other sources, refer to the instruction manual.

**2. Power-cord protection** – Power-supply cords should be routed so that they are not likely to be walked on or pinched by items placed upon or against them, pay particular attention to cords at plugs, convenience receptacles, and the point where they exit from the appliance.

Never pull or stretch the cord.



**3. CAUTION – Polarization** – This appliance may be equipped with a polarized alternating-current line plug (a plug having one blade wider than the other). This plug will fit into the power outlet only one way. This is a safety feature. If you are unable to insert the plug fully into the outlet, try reversing the plug. If the plug should still fail to fit, contact your electrician to replace your obsolete outlet. Do not defeat the safety purpose of the polarized plug.

**4. Ventilation** – Slots and openings in the cabinet are provided for ventilation and to ensure reliable operation of the appliance and to protect it from overheating, and these openings must not be blocked or covered. The appliance should be situated so that its location or position does not interfere with its proper ventilation.

To maintain good ventilation, do not put records or a tablecloth on the appliance. Place the appliance at least 10 cm away from the walls.

Do not use the appliance on a bed, sofa, rug or similar surface that may block the ventilation openings. This appliance should not be placed in a built-in installation such as a bookcase or rack unless proper ventilation is provided or the manufacturer's instructions have been adhered to.



**5. Water and moisture** – The appliance should not be used near water - for example, near a bathtub, washbowl, kitchen sink, laundry tub, in a wet basement, or near a swimming pool, etc.

**6. Temperature** – The appliance may not function properly if used at extremely low, or freezing temperatures. The ideal ambient temperature is above +5°C (41°F).

**7. Heat** – The appliance should be situated away from heat sources such as radiators, heat registers, stoves, or other appliances (including amplifiers) that produce heat.

**8. Electric shock** – Care should be taken so that objects do not fall and liquid is not spilled into the enclosure through openings. If a metal object, such as a hair pin or a needle, comes into contact with the inside of this appliance, a dangerous electric shock may result. For families with children, never permit children to put anything, especially metal, inside this appliance.



**9. Enclosure removal** – Never remove the enclosure. If the internal parts are touched accidentally, a serious electric shock might occur.



**10. Magnetic fields** – Keep the appliance away from sources of magnetic fields such as TV sets, speaker systems, radios, motorized toys or magnetized objects.

**11. Cleaning** – Unplug this appliance from the wall outlet before cleaning. Do not use volatile solvents such as alcohol, paint thinner, gasoline, or benzene, etc. to clean the cabinet. Use a clean dry cloth.

**12. Accessories** – Do not place this appliance on an unstable cart, stand, tripod, bracket, or table. The appliance may fall, causing serious injury to a child or adult, and serious damage to the appliance. Use only with a cart, stand, tripod, bracket, or table recommended by the manufacturer, or sold with the appliance. Any mounting of the appliance should follow the manufacturer's instructions, and should use a mounting accessory recommended by the manufacturer. An appliance and cart combination should be moved with care. Quick stops, excessive force, and uneven surfaces may cause the appliance and cart combination to overturn.



**13. Lightning** - For added protection for this appliance during a lightning storm, or when it is left unattended and unused for long periods of time, unplug it from the wall outlet and disconnect the antenna or cable system. This will prevent damage to the appliance due to lightning and power-line surges.

**14. Abnormal smell** - If an abnormal smell or smoke is detected, immediately turn the power OFF and unplug the appliance from the wall outlet. Contact your dealer or nearest service center.



**15. Damage requiring service** - The appliance should be serviced by qualified service personnel when:

- A. The power-supply cord or the plug has been damaged.
- B. Objects have fallen, or liquid has been spilled into the appliance.
- C. The appliance has been exposed to rain or water.
- D. The appliance does not appear to operate normally by following the instruction manual. Adjust only those controls that are covered by the instruction manual as an improper adjustment of other controls may result in damage and will often require extensive work by a qualified technician to restore the appliance to its normal operation.
- E. The appliance has been dropped, or the enclosure damaged.
- F. The appliance exhibits a marked change in performance.

**16. Servicing** - The user should not attempt to service the appliance beyond that described in the instruction manual. All other servicing should be referred to qualified service personnel.

**17. Outdoor antenna grounding** - If an outside antenna is connected to the appliance, be sure the antenna system is grounded so as to provide some protection against voltage surges and built up static charges. Article 810 of the National Electrical Code ANSI/NFPA 70, provides information with respect to proper grounding of the mast and supporting structure, grounding of the lead-in wire to an antenna discharge unit, size of grounding conductors, location of antenna discharge unit, connection to grounding electrodes, and requirements for the grounding electrode. See Figure.

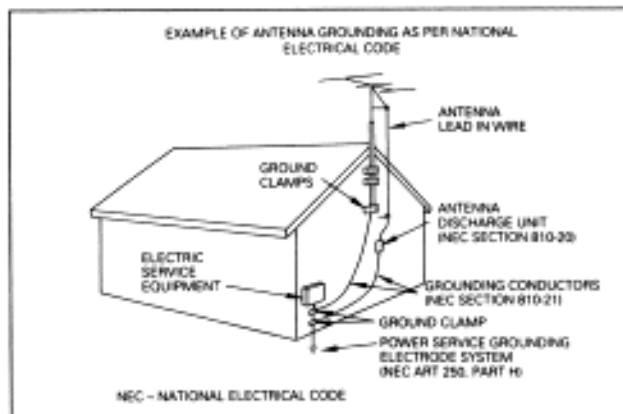

**18. Power lines** - An outside antenna system should not be located in the vicinity of overhead power lines or other electric light or power circuits, or where it can fall into such power lines or circuits. When installing an outside antenna system, extreme care should be taken to keep from touching such power lines or circuits as contact with them might be fatal.

**19. AC outlets** - Do not connect other audio equipment with a power consumption larger than that specified to the AC outlet on the rear panel. Never connect other electrical appliances, such as an iron or toaster, to it to prevent fire or electric shock.

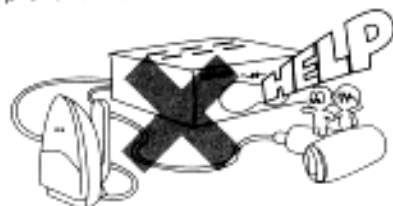

**20. Overloading** - Do not overload wall outlets, extension cords, or integral convenience receptacles as this can result in a risk of fire or electric shock.

**21. Attachment** - Do not use attachments not recommended by the appliance manufacturer as they may cause hazards.

**22. Replacement parts** - When replacement parts are required, be sure the service technician has used replacement parts specified by the manufacturer or have the same characteristics as the original parts. Unauthorized substitutions may result in fire, electric shock, or other hazards.

**23. Safety check** - Upon completion of any service or repairs to this appliance, ask the service technician to perform safety checks to determine that the appliance is in proper operating condition.

Notes:

1. Item 3 is not required except for grounded or polarized equipment.
2. Item 17 and 18 are not required except for units provided with antenna terminals.
3. Item 17 complies with UL in the U.S.A.